



Joint Engineering Data Management Information and Control System (JEDMICS)

System Functionality Overview

Contract Number: FA807516D0008

Order Number: FA807519F1659

Mark Madalena
Program Manager

**Provide Searchable, Complete and Accurate Data in a
Secure Environment**

JEDMICS is a digital library for storing and publishing unclassified engineering data to support weapon system life cycle management and provides access to over 100M engineer drawings and associated data / documentation to over 16K active DoD users and government contractors.

Environment

JEDMICS Operating Environment

JEDMICS is a digital library that is the recipient of data from systems that maintain configuration of the technical data

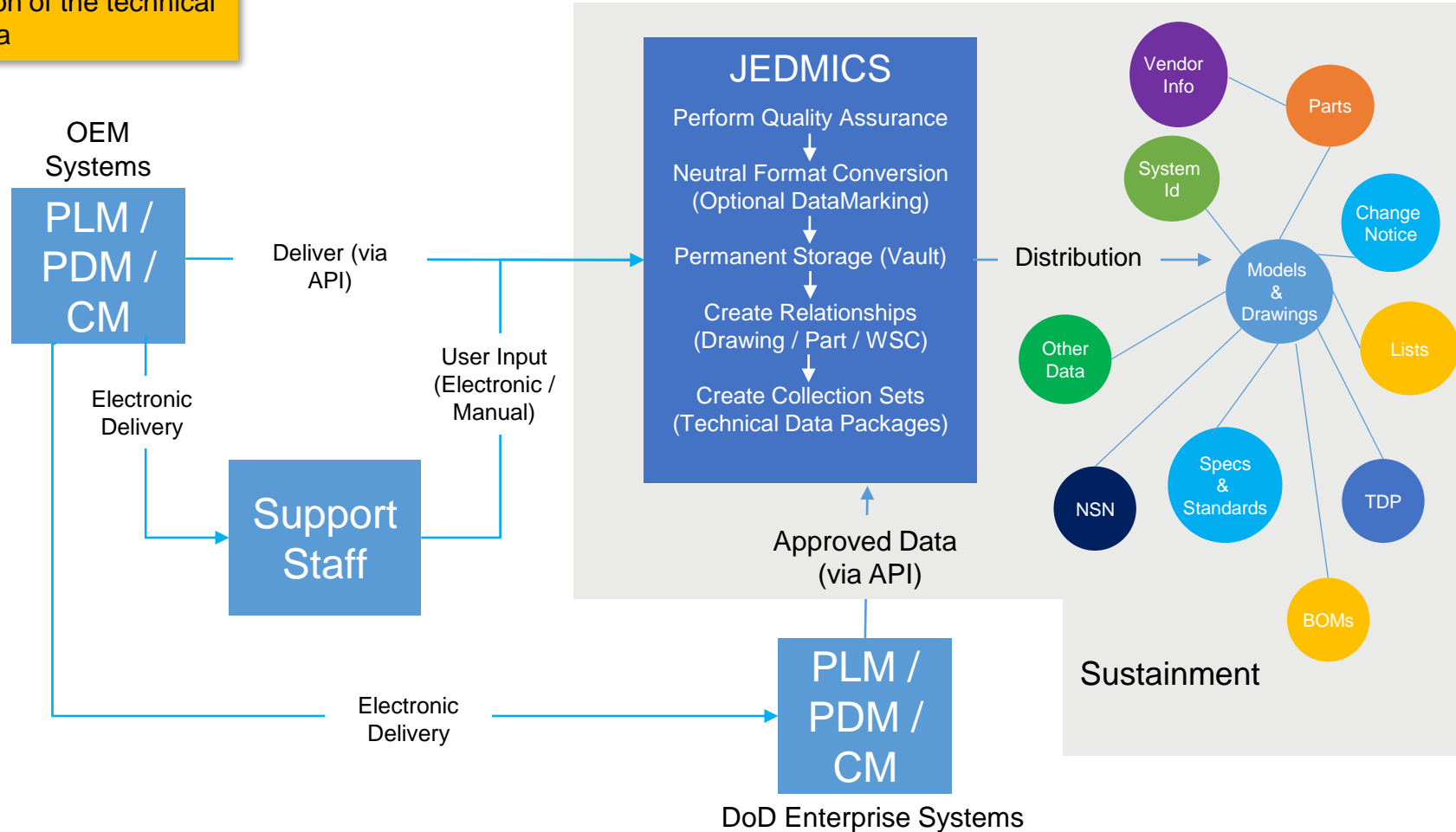

JEDMICS Modules

Module Description

- **Import**
 - The input components enable the electronic submission or import of drawings and index data into JEDMICS.
- **Pending Storage**
 - Provides the capability to perform quality assurance on data prior to making the data available to the community of use.
- **Permanent Storage**
 - Provides the capability to store and manage data used to perform maintenance and procurement activities
- **Collection Sets**
 - Provides the capability to provide collections of data in a structured and unstructured set
- **Export**
 - The export components provide the capability to electronically export drawings and index data out of JEDMICS.
- **Offline Request Server (ORS)**
 - The ORS Component provides a capability to perform updates / edits, bulk imports/exports, and reporting
- **Administration**
 - Provides the administration of users, devices, system configuration and offline request server access / job requests

JEDMICS Modules

Module Interaction / Functions

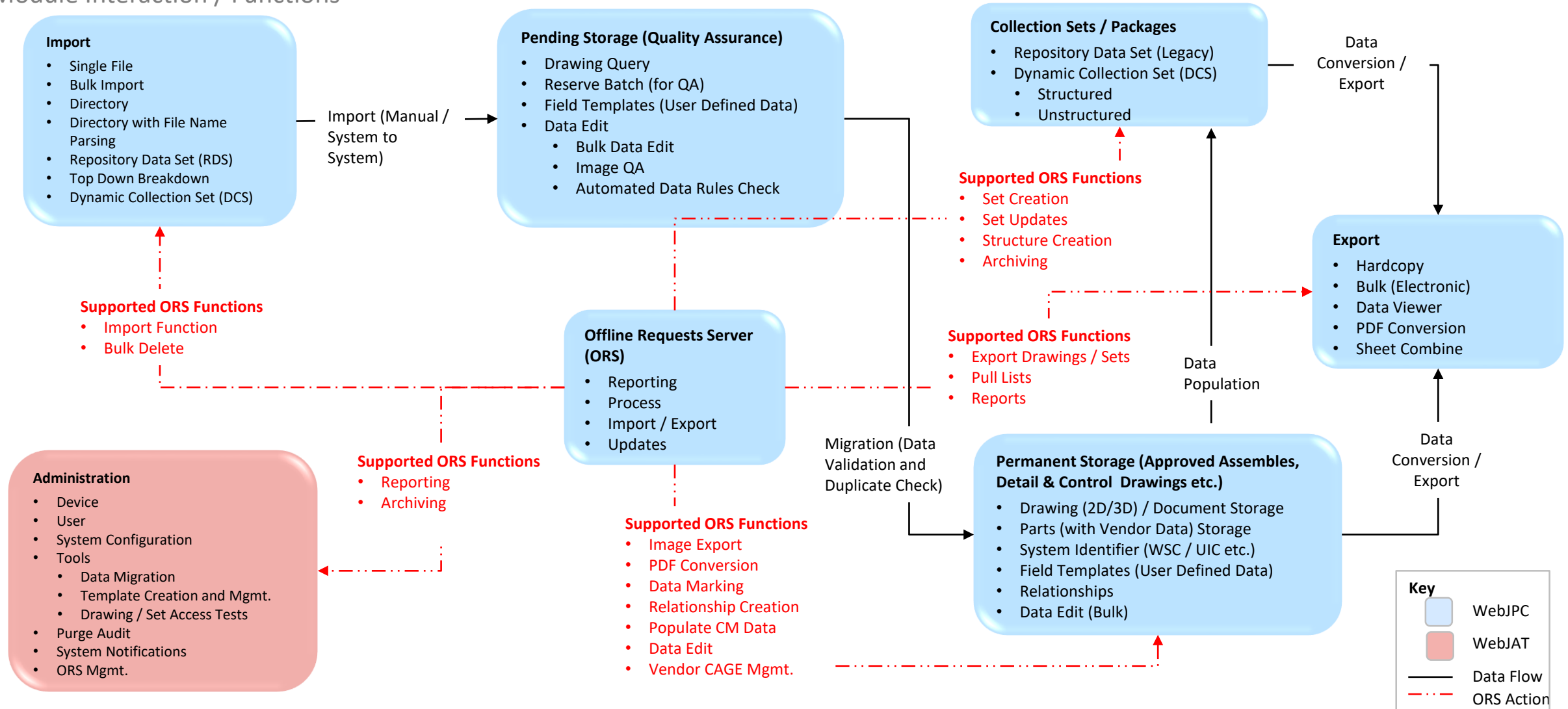

Key Features

JEDMICS Key Features

Features Description

- **Bulk Import / Export**

- Mass Data Loading and Export of Data
- Data Validation on Import
- PDF Convert and Combine on Export

- **Drawing / Document Storage**

- 2D/CAD Management / Storage (795 Supported File Types)
- Discretionary Access Control (Restrict access to sensitive data based upon the specific drawing(s) being accessed)
- Auditing (Audit Trail of Security Relevant Operations)
- 2D PDF Conversion & Data Marking (Automated and Manual Protective Markings)
- Field Templates (Site Defined FYI Fields)
- Bulk Data Edit / Management Tools (Supporting Quality Assurance)
- Data Validation (Site Specific)

- **Part Revisions**

- Field Templates (Site Defined FYI Fields)
- Vendor Detail

JEDMICS Key Features

JEDMICS Baseline Release 3.0.22

▪ Relationships

- Ad-hoc relationships between the Parts / Weapons System Codes (System Identifiers) / Drawings / Collection and Data Sets / Accompanying Documents
- Multiple Relationship Types Supported (i.e. Parent of, Equivalent, Substitute etc.)
- Assess impact of changes to a system

▪ Collection Sets

- Collection Sets consist of a list of Drawing Revisions and/or Sheets that can be managed as a unit.
- Types:
 - Repository Data Sets (RDS) - Static list of Drawing Revisions and/or Sheets
 - Dynamic Collection Sets (DCS) - Dynamic list of Drawing Revisions and/or Sheets. (Can contain parts / WSCs)
 - There are two types of DCS
 - Structured DCS - Associated with a Work Breakdown Structure (WBS), which is a hierarchical parent/child structure
 - Unstructured DCS - presented to the user as a flat list
 - Field Templates (Site Defined FYI Fields for Collection Elements)

JEDMICS Key Features

JEDMICS Baseline Release 3.0.22

- **Offline Request Server (ORS)**

- Allows JEDMICS users (with appropriate permissions) to execute operations in background
- Actions include
 - Reports
 - Update / Edits
 - Import / Export

Example ORS Action - Generated Part List

1	A	B	C	D	E	F	G	H	I	J	K	L	M	N	O	P
1	PART LIST	DESIGN ACTIVITY	ORIGINAL CAGE	CURRENT CAGE	LIST NO	REVISION	LIST TITLE	END ITEM	SHEET							
2		PERATON GOVERNMENT COMMUNICATIONS INC.1	OUF45	OUF45	PL MRM-52820	A	PERATON WIDGET	MRM-1/1	1							
3	MANAGING SITE	FSC	NIIN	ODA	CDA	GOVERNMENT DEPO	CONTRACTOR DEPOT									
4	PERATON	4576	904433322	6S125	OUF45	NATEC	ALBUQUERQUE									
5																
6																
7				OUF45	MRM52820	A	MRM52820	A	0001	PERATON WIDGET						
8	6	AR	OZ	VICD	528022-3	A	528022	A	0001	PERATON WIDGET	4			DIAGRAM 4 REMARK 4 NOTE 4	ZONE 2	
9	5	AR	OZ	VICD	755282021-110	A	755282021	A	0002	PERATON WIDGET	6			DIAGRAM 5 REMARK 5 NOTE 1	ZONE 3	
10	4	AR	OZ	VICD	755282021-110	A	755282021	B	0002	PERATON WIDGET	3			DIAGRAM 4 REMARK 4 NOTE 4	ZONE 2	
11	3	AR	OZ	VICD	455282021-12	A	455282021	A	0001	PERATON WIDGET	3			DIAGRAM 3 REMARK 3 NOTE 3	ZONE 2	
12	2	AR	OZ	VICD	15282021-10	A	15282021	A	0001	PERATON WIDGET	2			DIAGRAM 2 REMARK 2 NOTE 2	ZONE 2	
13	1	SUBST	OZ	VICD	15282022-1					PERATON WIDGET	4					
14	1	AR	OZ	VICD	5282021-101	A	5282021	A	0001	PERATON WIDGET	4			DIAGRAM 1 REMARK 1 NOTE 1	ZONE 1	
15	FND NO	QTY REQ	UNIT MEAS	CAGE CODE	PART OR IDENT NO	DRAWING SIZE	DOCUMENT NUMBER	REVISION	SHEET NO	NOMENCLATURE/DESCRIPTION	WEIGHT	HCI/HCP	SUPL LIST	MATERIAL SPECIFICATION	ZONE	SYMBOL

Document Management

JEDMICS Features

Document / Drawing Search

- Multiple Search Mechanisms (including Number (Identifier) / CAGE / Title / Weapons System Code)
- Multiple Filters (Document Type / Revision / Sheet Number)
- Text Search (Meta Data and Text Contained in Drawing / Document)
- Field Template (FYI Field Values)

azure2 - WebJPC Main Window - Profile 1 - Microsoft Edge
 https://jedmics2-web.jedmics.us/certificate/certificatereader?warningConfirmation=ACCEPTED&s508=Z0

Perm> Pend> Sets> Working List> Queue> Tools> ORS> Help> [MADALMA] azure2

Permanent Document/Part/WSC Query

Number: CAGE: Doc Type: All Null

Revision: All Highest Null

Include Acc Doc(s): All Highest Revision None

Also search Part Numbers.

Object Type(s): Drawing Revision Document Technical Data Package

Sheet Number: Source Site: WSC:

Drawing Title:

Include File Type Filters: Src Flavor: Dst Flavor: Content: Format: Ext: FTNum: FileType:

Exclude File Type Filters: Src Flavor: Dst Flavor: Content: Format: Ext: FTNum: FileType:

Last accessed more recently than: DD-MMM-YYYY

Text Search: Search for the exact phrase

Field(s) Search: Field Template ID: Templates Retrieve Fields Use AND or OR to link multiple search fields

Add Update Click 'Retrieve Fields' Button Equal To Remove Search Flds

Row	Template	Field	Symbol	Value	Edit	Remove

Query Return Size: 25 Clear Show Drawing Title Results

JEDMICS Features

Document / Drawing Query

Drawing Detail (Top Frame) and Image Detail (Lower Frame)

Display / View multiple drawing / revisions

Create Working List (Shopping Cart for Drawings to Export)

Bulk Edit / Edit (If permitted based on User Role)

Pull List (Export File) and Report

Add to Notification List (Watch list to be notified of updates to drawings)

The screenshot displays the 'Document Query' interface in a web browser. At the top, there is a navigation menu with options like 'Perm', 'Pend', 'Sets', 'Working List', 'Queue', 'Tools', 'ORS', and 'Help'. Below this is a toolbar with various icons. The main area features a table with 17 columns: Row, Detail, Plot, Drawing Number, CAGE, Doc Type, Rev Type, Obj Type, High Rev, Dwg Rev, Drawing Title, Dist Stmt, Sec, For, Nuc, Sub Safe, Exp, and Field Template. The table contains 7 rows of data, with the 6th row highlighted in yellow. Below the table, there are several tabs: 'Image List', 'Attributes', 'MSS', 'Fields', 'Relationships', 'Move', 'BulkEdit', 'PI NI PD ND PA NA'. The 'Attributes' tab is active, showing a detailed view of the selected drawing (JBR3022-MUI-4, CAGE 0UF45, DocType TDD, Rev A). This view includes fields for Drawing Number, CAGE, Doc Type, High Rev, Dwg Rev, Rev Type, TDAC, Ctrl Code, Dist Stmt, and Obj Type. It also has sections for Sheet information, Security (Sec, Size, Rights, Foreign, Nuclear, SubSafe, Export, QA, Status, Source Site), Revision (Rev Date, Drawing Title, Comment), and a TOC (Table of Contents) section with buttons for 'View TOC' and 'ReGen TOC'. A 'Save' button is located at the bottom of the detailed view.

Row	Detail	Plot	Drawing Number	CAGE	Doc Type	Rev Type	Obj Type	High Rev	Dwg Rev	Drawing Title	Dist Stmt	Sec	For	Nuc	Sub Safe	Exp	Field Template
3	<input type="checkbox"/>	<input type="checkbox"/>	JBR3022-MUI-4	0UF45	DD	SUBREV	DR	B		Peraton Drawings	A	N	N	N	N	N	
2	<input type="checkbox"/>	<input type="checkbox"/>	JBR3022-MUI-4	0UF45	DD	SUBREV	DR	B	B	Peraton Drawings	A	N	N	N	N	N	
7	<input type="checkbox"/>	<input type="checkbox"/>	JBR3022-MUI-4	7UUY6	TDD	SUBREV	DR	A	A	Peraton Drawings	A	N	N	N	N	N	
6	<input checked="" type="checkbox"/>	<input checked="" type="checkbox"/>	JBR3022-MUI-4	0UF45	TDD	SUBREV	DR	A	A	Peraton Drawings		N	N	N	N	N	PERATON
5	<input type="checkbox"/>	<input type="checkbox"/>	JBR3022-MUI-4	0UF45	PL	SUBREV	DR	A	A	Peraton Drawings	A	N	N	N	N	N	
4	<input type="checkbox"/>	<input type="checkbox"/>	JBR3022-MUI-4	0UF45	DL	SUBREV	DR	A	A	Peraton Drawings		N	N	N	N	N	
1	<input type="checkbox"/>	<input type="checkbox"/>	JBR3022-MUI-4	0UF45		SUBREV	DR	A	A	Peraton Drawings	A	N	N	N	N	N	

JEDMICS Features

Document / Drawing Display

azure2 - WebJPC Main Window - Profile 1 - Microsoft Edge
 https://jedmics2-web.jedmics.us/certificate/certificatereader?warningConfirmation=ACCEPTED&s508=Z0

Perm> Pend> Sets> Working List> Queue> Tools> ORS> Help>

Document Query [MADALMA] azure2

Rows 1 to 7 of 7

Row	Detail	Plot	Drawing Number	CAGE	Doc Type	Rev Type	Obj Type	High Rev	Dwg Rev	Drawing Title	Dist Stmt	Sec	For	Nuc	Sub Safe	Exp	Field Template
3	<input type="checkbox"/>	<input type="checkbox"/>	JBR3022-MUI-4	0UF45	DD	SUBREV	DR	B		Peraton Drawings	A	N	N	N	N	N	
2	<input type="checkbox"/>	<input type="checkbox"/>	JBR3022-MUI-4	0UF45	DD	SUBREV	DR	B	B	Peraton Drawings	A	N	N	N	N	N	
7	<input type="checkbox"/>	<input type="checkbox"/>	JBR3022-MUI-4	7UUY6	TDD	SUBREV	DR	A	A	Peraton Drawings	A	N	N	N	N	N	
6	<input checked="" type="checkbox"/>	<input checked="" type="checkbox"/>	JBR3022-MUI-4	0UF45	TDD	SUBREV	DR	A	A	Peraton Drawings	N	N	N	N	N	N	PERATON
5	<input type="checkbox"/>	<input type="checkbox"/>	JBR3022-MUI-4	0UF45	PL	SUBREV	DR	A	A	Peraton Drawings	A	N	N	N	N	N	
4	<input type="checkbox"/>	<input type="checkbox"/>	JBR3022-MUI-4	0UF45	DL	SUBREV	DR	A	A	Peraton Drawings	N	N	N	N	N	N	
1	<input type="checkbox"/>	<input type="checkbox"/>	JBR3022-MUI-4	0UF45		SUBREV	DR	A	A	Peraton Drawings	A	N	N	N	N	N	

Image List Attributes MSS Fields Relationships Move BulkEdit PI NI PD ND PA NA

Dwg JBR3022-MUI-4 CAGE 0UF45 DocType TDD Rev A

Field Template ID: PERATON Query Templates Retrieve Fields Merge Prev Revision

Field Save Options: Detailed Revision

Show All Data Only

Row	Field	Description	Value	Type
1	-[Managing Site]	Site organization responsible for the management of this data	Herndon VA	TEXT
2	FSC		6482	NUMBER
3	NIN		522777114	NUMBER
4	ODA		5M640	TEXT
5	CDA		0	TEXT
6	Government Depot		NATEC	TEXT
7	Contractor Depot		Herndon	TEXT

Drawing Field Template (User Defined FYI Values) View

azure2 - WebJPC Main Window - Profile 1 - Microsoft Edge
 https://jedmics2-web.jedmics.us/certificate/certificatereader?warningConfirmation=ACCEPTED&s508=Z0

Perm> Pend> Sets> Working List> Queue> Tools> ORS> Help>

Document Query [MADALMA] azure2

Rows 1 to 7 of 7

Row	Detail	Plot	Drawing Number	CAGE	Doc Type	Rev Type	Obj Type	High Rev	Dwg Rev	Drawing Title	Dist Stmt	Sec	For	Nuc	Sub Safe	Exp	Field Template
3	<input type="checkbox"/>	<input type="checkbox"/>	JBR3022-MUI-4	0UF45	DD	SUBREV	DR	B		Peraton Drawings	A	N	N	N	N	N	
2	<input type="checkbox"/>	<input type="checkbox"/>	JBR3022-MUI-4	0UF45	DD	SUBREV	DR	B	B	Peraton Drawings	A	N	N	N	N	N	
7	<input type="checkbox"/>	<input type="checkbox"/>	JBR3022-MUI-4	7UUY6	TDD	SUBREV	DR	A	A	Peraton Drawings	A	N	N	N	N	N	
6	<input checked="" type="checkbox"/>	<input checked="" type="checkbox"/>	JBR3022-MUI-4	0UF45	TDD	SUBREV	DR	A	A	Peraton Drawings	N	N	N	N	N	N	PERATON
5	<input type="checkbox"/>	<input type="checkbox"/>	JBR3022-MUI-4	0UF45	PL	SUBREV	DR	A	A	Peraton Drawings	A	N	N	N	N	N	
4	<input type="checkbox"/>	<input type="checkbox"/>	JBR3022-MUI-4	0UF45	DL	SUBREV	DR	A	A	Peraton Drawings	N	N	N	N	N	N	
1	<input type="checkbox"/>	<input type="checkbox"/>	JBR3022-MUI-4	0UF45		SUBREV	DR	A	A	Peraton Drawings	A	N	N	N	N	N	

Image List Attributes MSS Fields Relationships Move BulkEdit PI NI PD ND PA NA

Dwg JBR3022-MUI-4 CAGE 0UF45 DocType TDD Rev A

Rows 1 to 1 of 1 All Relationships on Delete Merge Prev Revision

DWG DWGREV PART PARTREV DCS TDB WSC

Refresh Popup Relationships Create DCS Traverse Relationships List Relationships

Row	Relationship	List Id	Source	Object	Identifier	CAGE	Doc Type	Revision	Description	Other Rel
1	Child of	JBR3022-MUI-4 0UF45 DL A	DWGREV	DWGREV	JBR3022-MUI-4	0UF45	DL	A	Peraton Drawings	Y

Query

Related Data View

JEDMICS Features

All Objects Query

Allows for Query of all Objects in the System

Filter Returns by Object Type

Query by Identifier / Text (Meta Data and Image) and Field Template Data

View Object Relationships

Object	Identifier	CAGE	Doc Type	Revision	Description	Acc Num	Acc CAGE	Acc Doc Type	Acc Rev	Batch Num	Batch Seq	Has Rel
11	DWGREV	JBR3022-MUI-4	0UF45	DD	Peraton Drawings							N
12	DWGREV	JBR3022-MUI-4	0UF45	DD	B	Peraton Drawings						N
13	DWGREV	JBR3022-MUI-4	0UF45	DL	A	Peraton Drawings						Y
14	DWGREV	JBR3022-MUI-4	0UF45	PL	A	Peraton Drawings						N
15	DWGREV	JBR3022-MUI-4	0UF45	TDD	A	Peraton Drawings						Y
16	DWGREV	JBR3022-MUI-4	7UJY6	TDD	A	Peraton Drawings						N
17	DWGREV	JBR3022-MUI-5	0UF45	TDD	A	Peraton Drawings						Y
18	DWGREV	JBR3022-MUI-5	0UF45	TDD	B	Peraton Drawings						Y
19	DWGREV	JBR3022-MUI-1A	0UF45	A	Peraton Null Values Drawing							N
20	DWGREV	JBR3022-MUI-1B	0UF45	TDD	A	Peraton Null Values Drawing						N
21	DWGREV	JBR3022-MUI-1C	0UF45	TDD	A	Peraton Null Values Drawing						Y
22	DWGREV	JBR3022-MUI-1D	0UF45	TDD	A	Peraton 2 Char Size						N
23	DWGREV	JBR3022-MUI-1E	0UF45	TDD	A	Peraton Null Export						Y
24	DWGREV	JBR3022-MUI-1F	0UF45	TDD	A	Peraton Extra Long Drawing						Y
25	DWGREV	JBR3022-MUI-1G	0UF45	TDD	A	Peraton Null Number of She						N
26	DWGREV	JBR3022-MUI-1H	0UF45	TDD	A	Peraton Null Number of Fra						N
27	DWGREV	JBR3022-MUI-1I	0UF45	TDD	A	Peraton All Fields Entered						N
28	PARTREV	JBR3022-MUI-PART-1	0UF45	A	Peraton Part							Y
29	PARTREV	JBR3022-MUI-PART-2	0UF45	B	Peraton Part							Y
30	WSC	JBR3022-MUI1			Peraton System							N
31	WSC	JBR3022-MUI1A			Peraton System							N

Provides Access to Object Data (Example Part Revision Detail including Vendor Detail)

Part Query

Part Number: JBR3022-MUI-PART-1

Part CAGE: 0UF45

Part Revision: A

Owner: [Empty]

Description: [Empty]

Part Properties

Original Vendor CAGE: 0UF45

Vendor CAGE: 0UF45

Vendor Id: PERATON GOVERNMENT COMMUNICATIONS INC.

Street: 12975 WORLDGATE DR STE 7103

City: HERNDON

State: VA

Zip Code: 20170-6008

Country: UNITED STATES

Part Query Results

Part Number	Part CAGE	Revision	Highest	Order
JBR3022-MUI-PART-1	0UF45	A	A	SUBREV

Relationships

JEDMICS Features

Data Relationship

JEDMICS Data Relationships
 JEDMICS provides the capability to relate any object to another object in the database.
 The relationships created can provide a complete picture of the configuration of a system.
 The relationships can be created manually / using file input (Excel / Text) and through JEDMICS APIs

- JEDMICS Supported Relationships**
- Related To
 - Supersedes / Superseded By
 - Modifies / Modified By
 - Equivalent To
 - Replaces / Replaced By
 - Parent Of / Child Of
 - Requires / Required By
 - Substitute / Substitute Of
 - Alternate / Alternate Of

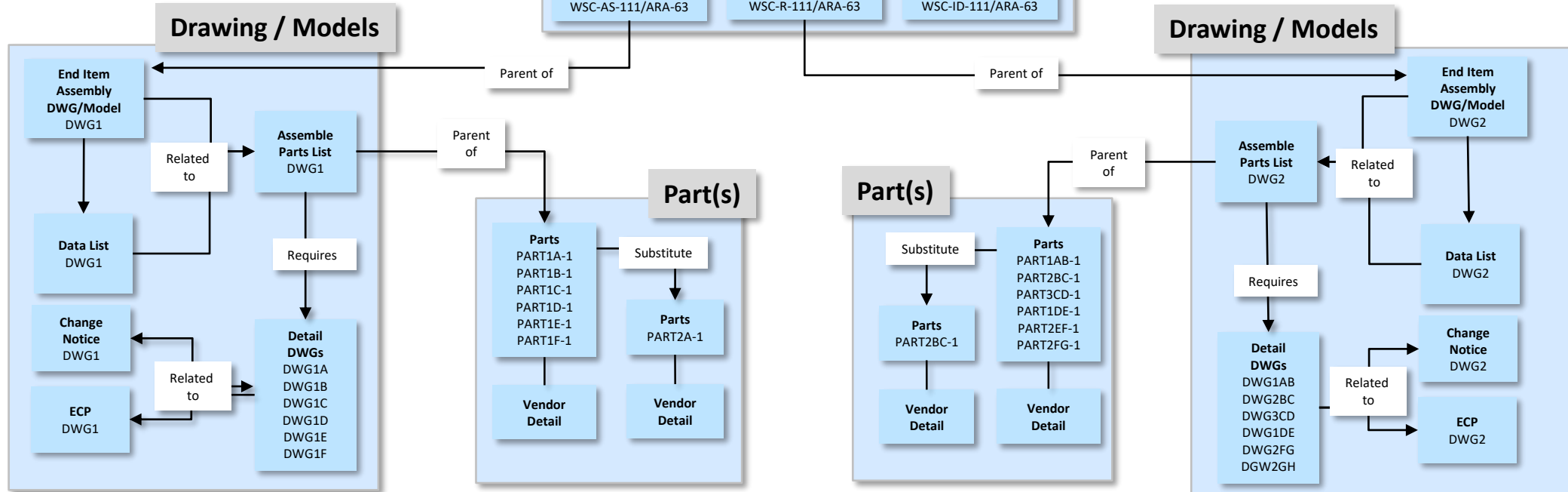
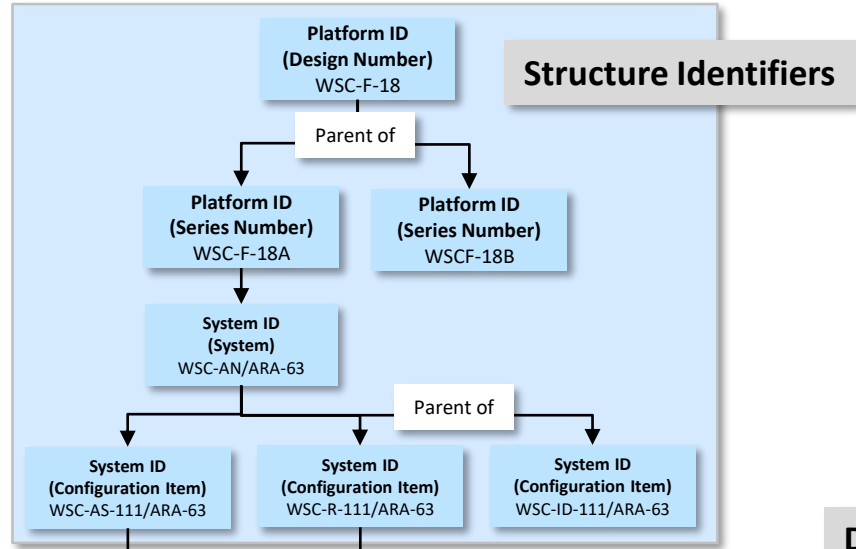

JEDMICS Features

Data Management / Configuration

Traverse Relationship
The JEDMICS Display of Relationships

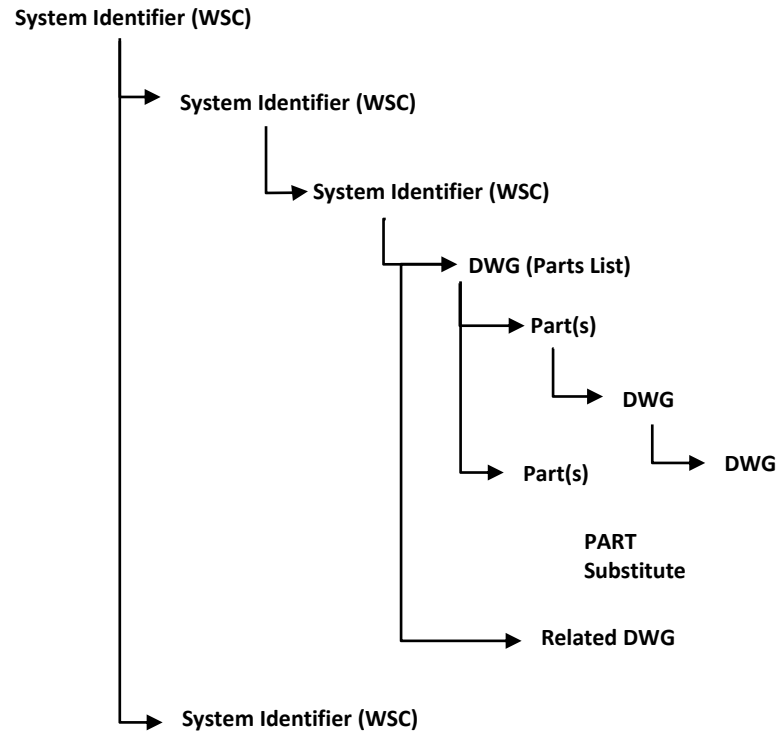

WSC WSC ID: MRM-1 SysId: 1400 - Traverse Relationships - Profile 1 - Microsoft Edge

https://jedmics2-web.jedmics.us/webjedmics/relationship/relationshipTreeGridFrameSet.htm?list=undefined&readonly=true&canedit=false

Relationship Query

Identifier: WSC WSC ID: MRM-1

Object Type(s):

DWG DWGREV PART PARTREV WSC TDB DCS RDS ACCREV PENDING

Relationship Type(s):

Relationship Query Results Total Relationship Rows: 1

Det	Chk	Objects	Object	Relationship	Identifier	CAGE	Doc Type	Revision	Title/Desc	Sheet Number
		Parent of	Parent of							
		WSC_MRM-1A_1401	WSC	Parent of	MRM-1A				Peraton Platform	
		Parent of	Parent of							
		WSC_MRM-1/1_1402	WSC	Parent of	MRM-1/1				Peraton Subsystem	
		Parent of	Parent of							
		DWGREV_MRM-52820_0UF45_PL_A_7980	DWGREV	Parent of	MRM-52820	0UF45	PL	A	Peraton Widget	
		Parent of	Parent of							
		PARTREV_528022-3_0UF45_A_478316	PARTREV	Parent of	528022-3	0UF45		A	Peraton Widget	
		PARTREV_755282021-110_0UF45_A_478315	PARTREV	Parent of	755282021-110	0UF45		A	Peraton Widget	
		Child of	Child of							
		DWGREV_755282021_0UF45_TDD_A_7977	DWGREV	Child of	755282021	0UF45	TDD	A	Peraton Widget	
		Related to	Related to							
		DWGREV_755282021_0UF45_CN_A_7976	DWGREV	Related to	755282021	0UF45	CN	A	Peraton Widget	
		PARTREV_755282021-110_0UF45_B_478314	PARTREV	Parent of	755282021-110	0UF45		B	Peraton Widget	
		PARTREV_455282021-12_0UF45_A_478313	PARTREV	Parent of	455282021-12	0UF45		A	Peraton Widget	
		PARTREV_15282021-10_0UF45_A_478312	PARTREV	Parent of	15282021-10	0UF45		A	Peraton Widget	
		PARTREV_5282021-101_0UF45_A_478311	PARTREV	Parent of	5282021-101	0UF45		A	Peraton Widget	
		Child of	Child of							
		DWGREV_5282021_0UF45_TDD_A_7974	DWGREV	Child of	5282021	0UF45	TDD	A	Peraton Widget	
		Substitute	Substitute							
		PARTREV_15282022-1_0UF45_A_478317	PARTREV	Substitute	15282022-1	0UF45		A	Peraton Widget	
		Related to	Related to							
		DWGREV_MRM52820_0UF45_DL_A_7979	DWGREV	Related to	MRM52820	0UF45	DL	A	Peraton Widget	
		Related to	Related to							
		WSC_MRM-1/2_1403	WSC	Parent of	MRM-1/2				Peraton Subsystem	
		WSC_MRM-1/3_1404	WSC	Parent of	MRM-1/3				Peraton Subsystem	

Status Bar

JEDMICS Features

Impact Reporting

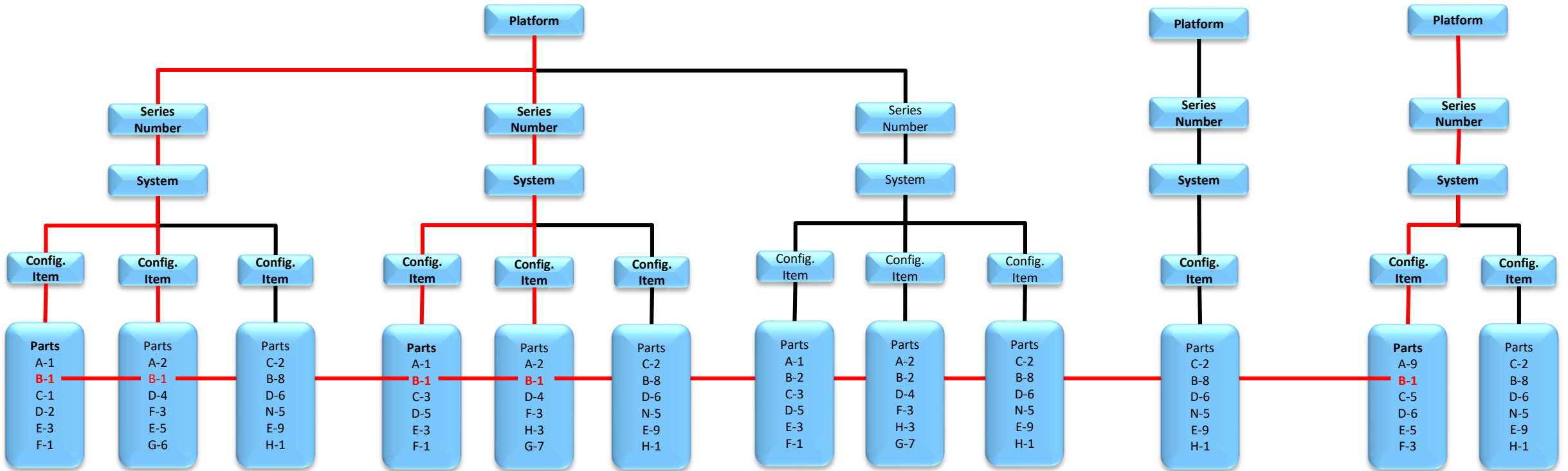

Impacted Object —

See impact of a change across configurations / platforms

Collection Sets

JEDMICS Features

Dynamic Collection Set (DCS) - Structured

Specified Drawing Revisions (SDR) – Dynamically Stored
Note: SDR does not have to exist in JEDMICS

Top Down Breakdown (TDB) / Work Breakdown Structures (WBS)

Users can view / export single image or complete set

Field Template (FYI Data)

JEDMICS Drawing Revisions (JDR) and Images

Has SDR	TDB Node ID	Description
N	AMAA / FA-18A	FA-18A Assemble
N	11000	AIRFRAME
N	11100	FWD FUSELAGE SECTION
Y	111100	RADOME ASSEMBLY
Y	111111	NOSE RADOME SUPPORT FITTING
Y	111112	RADOME ROTARY LATCH ASSEMBLY UPPER
Y	111111	RADOME ROTARY LATCH ASSEMBLY LOWER
Y	1111200	WINDSHIELD PANEL ASSEMBLY
Y	1111300	MOVABLE PILOTS CANOPY
N	111131	MOVABLE PILOTS CANOPY FRAME

Type	Dwg #/ID	CAGE	Rev	Remark
DWG	15282021	0UF45	A	
DWG	528022	0UF45	A	
DWG	755282021	0UF45	A	

Field Name	Value	Length
Configuration Qty	1	1
PartNo DESC	Widget	50
Position Code	L	2
Inv Class Code	A1	3
Inv Subclass Code	A23	3
Assoc TEC/ASSY Code	1356	4
Next Higher WUC	11000	10

Number	CAGE	Doc Type	High Rev	Rev	Drawing Title
15282021	0UF45	TDD	A	A	Peraton Widget

Sheet	#Sheets	Frame	#Frames	Rev	Rights	QA Status	Size	Sub sheet	File Ext
0001	0001	0001	0001	A	U		A		PDF

JEDMICS Features

Dynamic Collection Set (DCS) – Unstructured

Main[1] Dynamic Collection Sets (DCS) - Profile 1 - Microsoft Edge
 https://jedmics2-web.jedmics.us/webjedmics/dcs/dcsFrameSet.htm

List of SDRs

DCS: JBR3022-MUI-DCS3 Rev Date: 24-JUN-2021:09:27:21 Total Number of Rows: 10

	Type	Description	Dwg #/ID	CAGE	Doc Type	Rev	Acc Num	Acc Cage	Acc Kind	Acc Rev	Sheet	SubSheet	Frame	File Type	Rev Opt	AccRev Opt	Remark	Owner ID
5	<input checked="" type="checkbox"/>	DWG	JBR3022-MUI-1F	OUF45	TDD	A					[%]	%	[%]	%	[Specified]	[All]		
6	<input type="checkbox"/>	DWG	JBR3022-MUI-1H	OUF45	TDD	A					[%]	%	[%]	%	[Specified]	[All]		
7	<input type="checkbox"/>	DWG	JBR3022-MUI-2	OUF45	TDD	A					[%]	%	[%]	%	[Specified]	[All]		
8	<input type="checkbox"/>	DWG	JBR3022-MUI-4	OUF45	DL	A					[%]	%	[%]	%	[Specified]	[All]		
9	<input checked="" type="checkbox"/>	DWG	JBR3022-MUI-5	OUF45	TDD	B					[%]	%	[%]	%	[Specified]	[All]		
10	<input checked="" type="checkbox"/>	DWG	JBR3022-MUI-5	OUF45	TDD	A					[%]	%	[%]	%	[Specified]	[All]		

First Prev Rows 1 to 10 of 10 Next Last Page 1 25 rows per page

JEDMICS Dwg Num: JBR3022-MUI-5 CAGE: OUF45 DocType: TDD Dwg Rev: B Total Number of Rows: 1

	Number	CAGE	Doc Type	High Rev	Rev	Drawing Title	Dist	Sec	Nuc	For	Sub	Exp	Has Acc
1	<input checked="" type="checkbox"/>	JBR3022-MUI-5	OUF45	TDD	B	B	Peraton Drawings	N	N	N	N	N	Y
	<input type="checkbox"/>	Acc Number	Acc Cage	Acc Kind	High Rev	Acc Rev	Acc Title	Dist	Sec	Nuc	For	Sub	Exp
1	<input type="checkbox"/>	JBR3022-MUIACC-1	OUF46	CN	A	A	Peraton Drawings	A	N	N	N	N	N
2	<input type="checkbox"/>	JBR3022-MUIACC-3	OUF45	CN	A	A	Peraton Drawings		N	N	N	N	N

First Prev Rows 1 to 1 of 1 Next Last Page 1 50 rows per page

JEDMICS Images Dwg Num: JBR3022-MUI-5 CAGE: OUF45 DocType: TDD Dwg Rev: B Total Rows: 1

	Sheet	#Sheets	Frame	#Frames	Rev	Rights	QA Status	Size	Sub sheet	File Ext	FT Num	Source Site	File Size	Can View
1	<input type="checkbox"/>	0001	0001	0001	B	U		A		PDF	29		382.5 KB	Y

First Prev Rows 1 to 1 of 1 Next Last Page 1 50 rows per page

JEDMICS Drawing Revisions (JDR) and Images

Discretionary Access Control

JEDMICS Key Features

Access Control

- **JEDMICS objects that are subject to Discretionary Access restrictions are Drawing Revisions (and their associated Sheets), Part Revisions, RDS collections, and structured DCS collections.**
 - An Access Class is composed of a single Base Rule, plus zero or more optional rules that fall into the following categories:
 - **Source Site** (only applies to Drawing Revisions/Sheets): Allows access to be conditioned on the Source Site value assigned to drawing
 - **File Type** (only applies to Drawing Revisions/Sheets): Allows access to be conditioned (either granted or denied) based on the file type value assigned to a drawing
 - **Image Rules** (only applies to Drawing Revisions/Sheets): Allows access to be conditioned on the certain aspects of the index data assigned to a drawing
 - DWG_REV: Grants or denies image access based on a list of Drawings defined by drawing number, CAGE, doc type, and drawing revision (wild cards are not supported for any of these values). Multiple DWG_REV rules can be defined, though only one can be defined for a specific Drawing.
 - WSC/CAGE: Grants or denies image access based on a list of CAGE/WSC pairs, with capability to further restrict access for each pair specified by the security profile values of any matching Drawing Revisions. Multiple WSC/CAGE rules can be defined, though only one can be defined for a specific WSC/CAGE pair.
 - CAGE: Grants or denies image access based on a list of CAGE values, with capability to further restrict access for each value specified by the security profile values of any matching Drawing Revisions.
 - WSC: Grants or denies image access based on a list of WSC values, with capability to further restrict access for each value specified by the security profile values of any matching Drawing Revisions.
 - **Base Rule** (applies to all objects): Sets the default access permissions for a user if no other rule(s) in the Access Class apply to the object that has been queried

Mobile (Lite) Interface

JEDMICS Features

Mobile UI Drawing Query

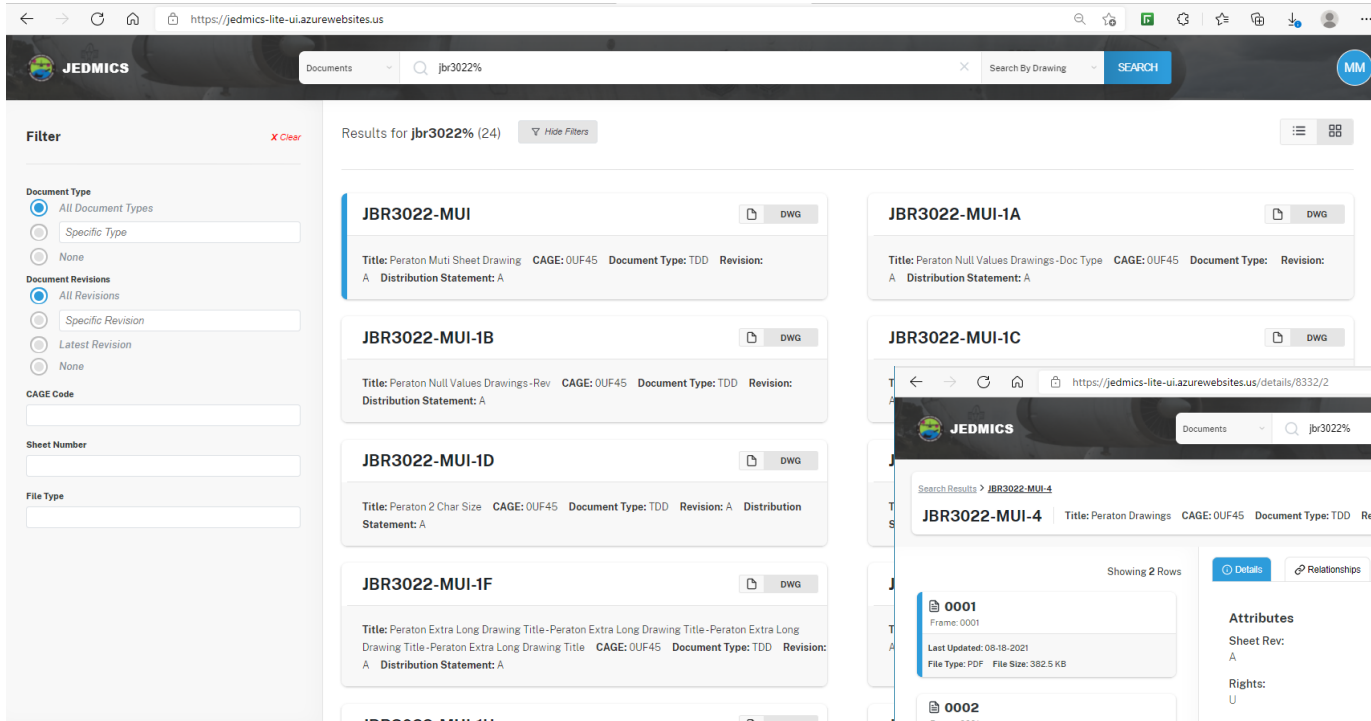

- The Mobile UI is a simplified read only interface for JEDMICS.
- Can be used on Desktop or Tablet
- Provides Access to Drawings using Drawing Number / Text or Part Number
- Provides Filter(s) that can be applied to result set.

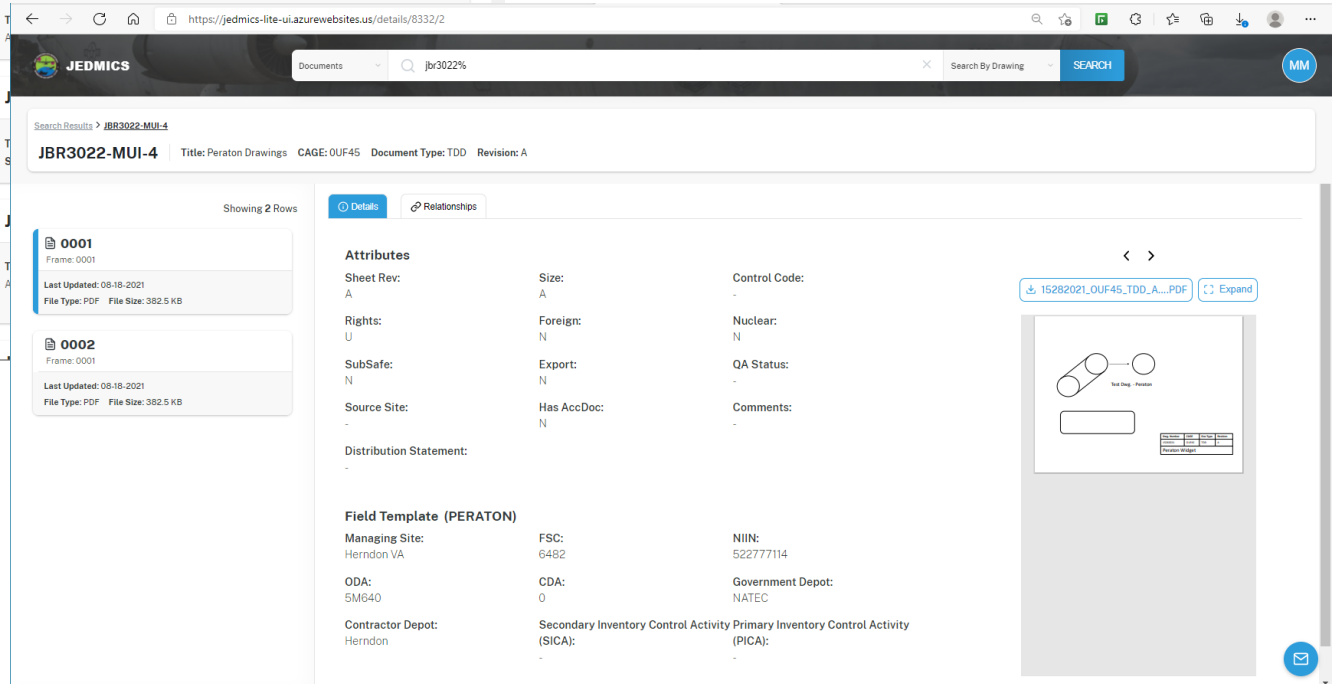

- Drawing Details provide a subset of meta data and view of Field Template Information.
- A preview of image is provided in the application
- Single Image and Complete Drawing can be downloaded
- If available Relationships and Accompanying Documents can be displayed

JEDMICS Features

Mobile UI Dynamic Collection Set (DSC)

Supports read only display of structured and unstructured DCS

The screenshot shows the JEDMICS mobile interface. On the left, a search results page for 'MRM-1' displays a hierarchical tree of Dynamic Collection Set (DCS) items. The tree starts with '1.0 (WSC) Id:MRM-1,ReLY' and branches into '1.1 Parent of', '1.1.1 (WSC) Id:MRM-1A,ReLY', '1.1.1.1 Parent of', '1.1.1.1.1 (WSC) Id:MRM-1/1,ReLY', '1.1.1.1.1.1 Parent of', '1.1.1.1.1.1.1 (DWGREV) Id:MRM-52820,CAGE:0UF45,DT:PL,Rev:A,ReLY', '1.1.1.1.1.1.1.1 Parent of', '1.1.1.1.1.1.1.1.1 (PARTREV) Id:5282021-101,CAGE:0UF45,Rev:A,ReLY', '1.1.1.1.1.1.1.1.2 (PARTREV) Id:15282021-10,CAGE:0UF45,Rev:A,ReLY', '1.1.1.1.1.1.1.1.3 (PARTREV) Id:455282021-12,CAGE:0UF45,Rev:A,ReLY', '1.1.1.1.1.1.1.1.4 (PARTREV) Id:755282021-110,CAGE:0UF45,Rev:B,ReLY', '1.1.1.1.1.1.1.1.5 (PARTREV) Id:755282021-110,CAGE:0UF45,Rev:A,ReLY', '1.1.1.1.1.1.1.1.6 (PARTREV) Id:528022-3,CAGE:0UF45,Rev:A,ReLY', and '1.1.1.1.1.1.2 Related to', '1.1.1.1.1.1.2.1 (DWGREV) Id:MRM52820,CAGE:0UF45,DT:DL,Rev:A,ReLY'. In the center, a table lists parts with columns: Type, ID, Cage, Doc Type, Revision, Sheet, Frame, File Type, and View Template. A row is highlighted for 'PART 5282021-101' with Cage '0UF45', Revision 'A', and a 'View Template' link.

Select link to display object details. In this example, a part is displayed

Part details allows for the user to view details about the part, any related data and vendor information.

The screenshot shows the detailed view for part '5282021-101'. The breadcrumb trail is 'MRM-1 > 5282021-101'. The part information includes: '5282021-101 | CAGE: 0UF45 | Revision: A | Description: Peraton Widget'. Below this, there are tabs for 'Details', 'Relationships', and 'Vendor'. The 'Details' tab is active, showing the following attributes:

Distribution:	A	Inactive:	Y	Unit of Measure:	OZ
Weight:	4	Symbol:	-	Hazard:	-
Vendor Item Number:	A5282021	Vendor Type:	VICD		

Below the attributes, there are three field templates:

- Field Template (Federal Supply Code)**: FSC: 4576
- Field Template (National Identification Item Number)**: NIIN: 904433322
- Field Template (Source, Maintenance, Recoverability, Code)**: SM&R: 368A
- Field Template (Primary Inventory Control Activity)**: PICA: 56788

JEDMICS Features

Mobile UI All Object Query

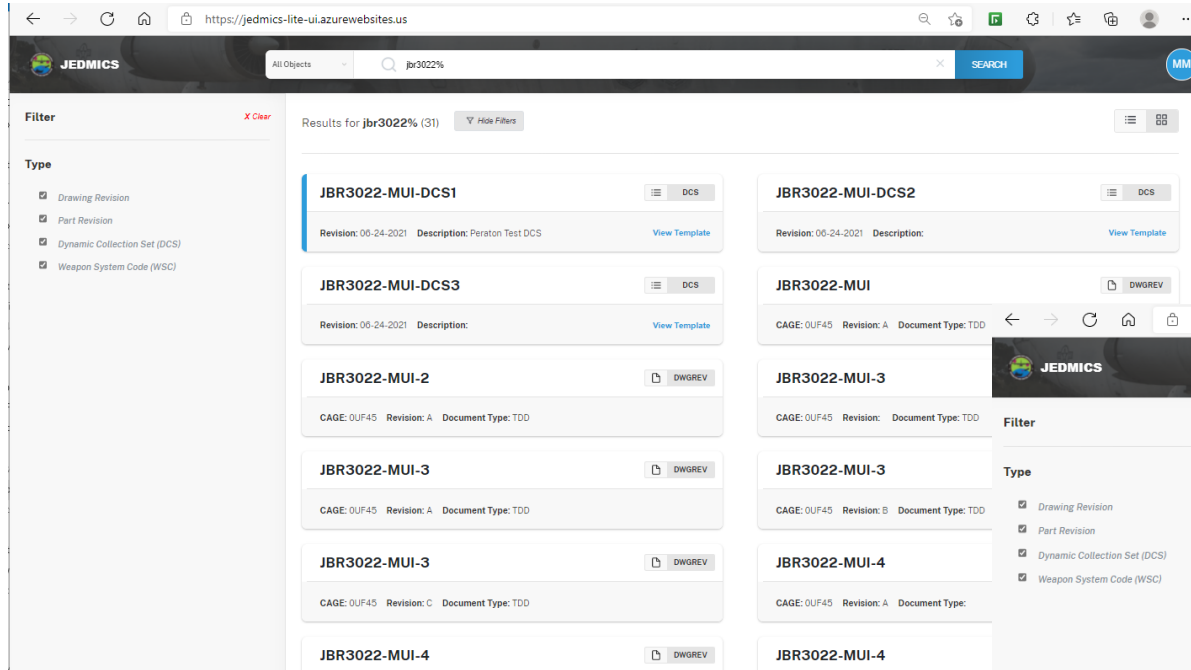

All Object query returns Drawing Revisions, Part Revisions DCSs and Weapon System Codes (WCS).
 The user can filter on type of object to be returned.
 The data is presented in a "card view"

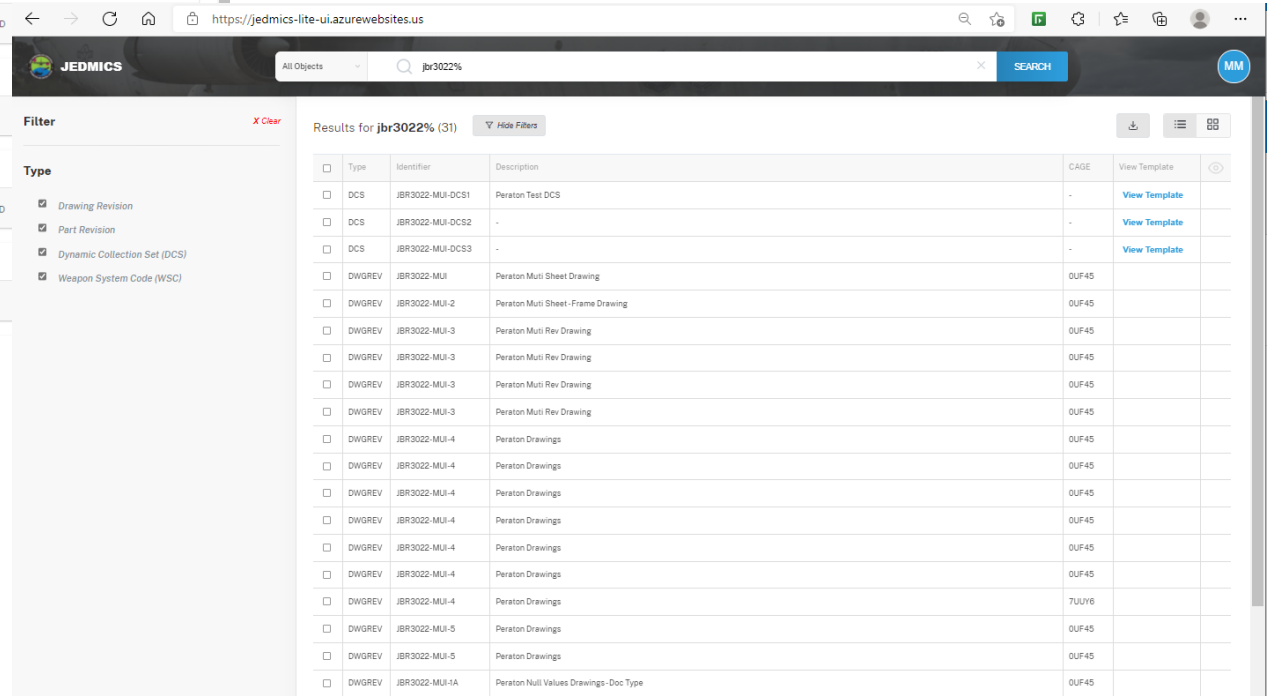

The user may change the view to be a grid / list view

Numbers

JEDMICS Numbers

Actual JEDMICS Site Transactions

- **Highest recorded number of concurrent users logged in at once (90 day period)**
 - **595** on March 17, 2021 (between 9:00AM and 10:00AM)
 - Note: The average number of concurrent users on workdays: **201** for period
- **Highest record daily transactions into the system (90 day period)**
 - number of files transmitted into system **2,520** files
 - physical size: **373.8** GB
- **Highest record daily volume of data transmitted out of system (90 day period)**
 - number of files: **26,856** files
 - physical size: **3.98** TB
- **Daily volume of data transmitted during peak hours (90 day period)**
 - In, by number of files: **1,050** files
 - In, by physical size: **155.8** GB
 - Out, by number of files: **11,190** files
 - Out, by physical size: **1.7** TB

Functionality Description

JEDMICS Detailed Functionality

Detailed and Unique Functionality

JEDMICS Functions	Description
Document / Drawing / Model Vaulting	JEDMICS can store any file type, with the exception of executable files, and includes 2D and CAD file storage. Complete documents / manuals can be stored in the system.
Automated Data Relationship (Using System to System or Load Files)	<p>JEDMICS allows for the creation of adhoc relationships to objects stored in the system. Those objects include Drawings, Parts, Weapon System Codes and Collection Sets.</p> <p>Relationship Types:</p> <ul style="list-style-type: none"> • Related To • Supersedes / Superseded By • Modifies / Modified By • Equivalent To • Replaces / Replaced By • Parent Of / Child Of • Requires / Required By • Substitute / Substitute Of • Alternate / Alternate Of
Bulk Import / Export of Data	JEDMICS provides standard import and export formats for meta data and images that are used as part of data delivery in DoD.
Text Content Search	JEDMICS provides the capability to search for text within documents stored in the system as part of the advance search function. The advance search function also returns documents that matches on the query based on metadata values.
Bulk Image Conversion to PDF (2D Images only)	PDF conversion process is an automated process to create a PDF version (neutral) of source images (single image or composite PDF) for existing permanent image repository (legacy), as well as process files newly introduced into permanent (runtime).

JEDMICS Detailed Functionality

Detailed and Unique Functionality

JEDMICS Functions	Description
Data Marking (protective markings that state any restrictions on the usage, handling, and distribution of the documents)	Data Marking application (an optional module to the Baseline Release) provides a solution that adds appropriate informational markings to documents (both sensitive and non-sensitive) extracted from JEDMICS, based on the index data maintained in JEDMICS for each document. Data Marking module supports the automatic rotation of image based on size, marking top and bottom of drawing, and automated remarking based on metadata changes.
Bulk Editing Capability	Allows a JEDMICS user to perform Bulk Edit operations on drawing meta data in both Pending and Permanent Storage. (User must be assigned this capability)
User Established Data Elements (Field Templates)	Field Templates are site-defined meta data fields that can be associated with an object. hose objects include Drawings, Parts, Weapon System Codes and Collection Sets.
Structured Data List (Hierarchal Structure) (DCS)	Provides the capability to create a dynamic list of Drawing Revisions and/or Sheets. DCS's contents are listed independently of the Permanent repository's contents, so a DCS content row (SDR) does not need to exist within the Permanent repository.
Automated Email Notifications	JEDMICS Supports email notification for account management (notification that password expiring or the user has not logged on to the system in a set number of days) and also the capability for users to get notification on changes / updates to drawings that the user can track from a configurable / set list.
List Reports	Detailed reporting including Part, Data and Assemble Lists
History Reporting	As part of Offline Request Server (ORS), users can create history reports for Permanent Drawings, DCS, Parts, WSCs
Auditing and Reporting (C2 Tracking)	JEDMICS tracks all login information (including failures) and tracks all changes, deletions, modifications and extractions (including views) to images.

JEDMICS Detailed Functionality

Detailed and Unique Functionality

JEDMICS Functions	Description
Exceptions Reporting	JEDMICS as part of ORS actions provide the capability to report missing elements (sheets / frames) of a drawing revision in permanent and pending storage.
APIs (System / Interface Integration)	JEDMICS also provides an open architecture interface using Java programming language standards called the JEDMICS Open Application Interface (OAI). Using the OAI or other standard mechanisms for data exchange, each Service can create their own customized means of accessing the data maintained within JEDMICS so as too best integrate that data into their business processes. Additionally, JEDMICS has a RESTful API to interact with the JEDMICS system.
CAC Enabled	Based on the PKI certificate the user selected when establishing the SSL connection between their browser and the JEDMICS Apache HTTP server, a user is authenticated to an associated JEDMICS user account. The association is made by recording the Distinguished Name value from the PKI certificate within the associated JEDMICS user account profile(s).
Discretionary Access Controls	Some objects in JEDMICS contain sensitive data in the form of proprietary rights, no foreign access, nuclear, submarine-safe and/or limited distribution data. The Discretionary Access mechanism allows the System Administrator to define restrictions on the access to sensitive data based upon the specific drawing(s) being accessed. For example, a System Administrator could allow a manufacturer's contractors the capability to access proprietary data in all drawings identified by their CAGE, but access only unlimited rights data for all other drawings.
Role Based Access	The capability of a user to access various functional areas is defined by the User Class to which they are assigned. A User Class consists of a list of functional areas and associated operations granted to any user assigned to that User Class.
Data Replication (COOP)	JEDMICS has automated processes for data replication on a secondary system that can be stood up if a issue causes the primary system go down for a extended period of time.
PDF Combine	On export of images, JEDMICS has the capability to convert images to neutral format (PDF), if needed, as well as combine multiple sheet documents into a single document.
Document / Zip File Table of Contents (TOC)	JEDMICS has the capability to read the contents of a multi page document and the contents of a ZIP file. This allows the user to go directly to a section / page of a multi sheet document and view. For a ZIP file, it allows for a user to extract specified files contained in the ZIP file for viewing.



**Contact Mark Madalena for
Demonstrations or Questions**

Mark.Madalena@peraton.com